



Store #222
 400 Route 15
 Sturbridge, MA 01566

Permit Drawing
 07.01.20
 J.0



#	by	description	date	#	by	description	date
E.0	CL	p3	04.24.20	G.1	CL	p3,	06.01.20
F.0	CL	p3	05.28.20	H.0	CL	p12	06.01.20
G.0	CL	p3	05.29.20	J.0	CL	p11	07.01.20

SITE LAYOUT | ARCHITECTURAL PLANVIEW

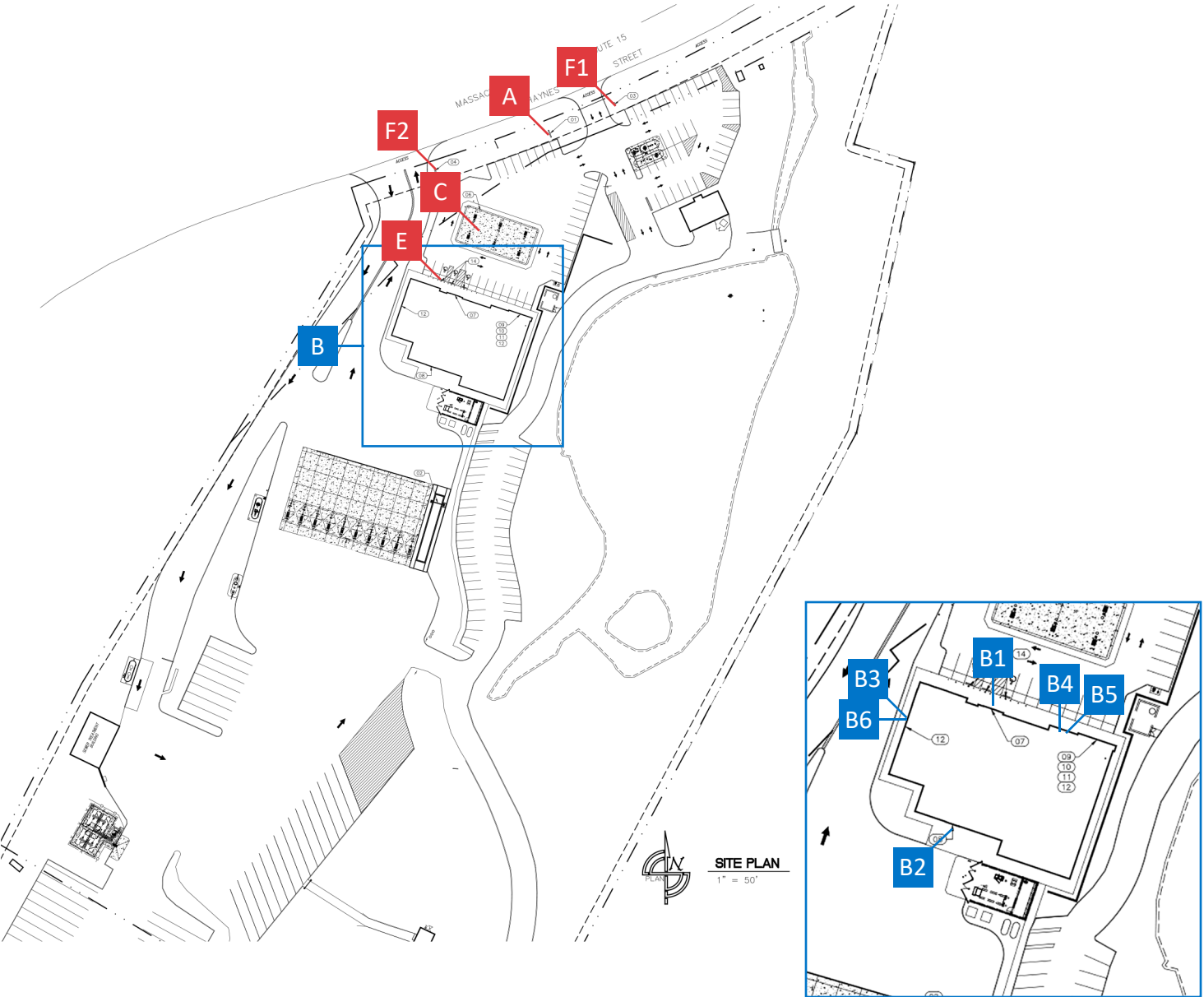

- A Single Pole System
- B Building Branding
- C Auto Products
- D Truck Products
- E Parking Signs
- F Directionals



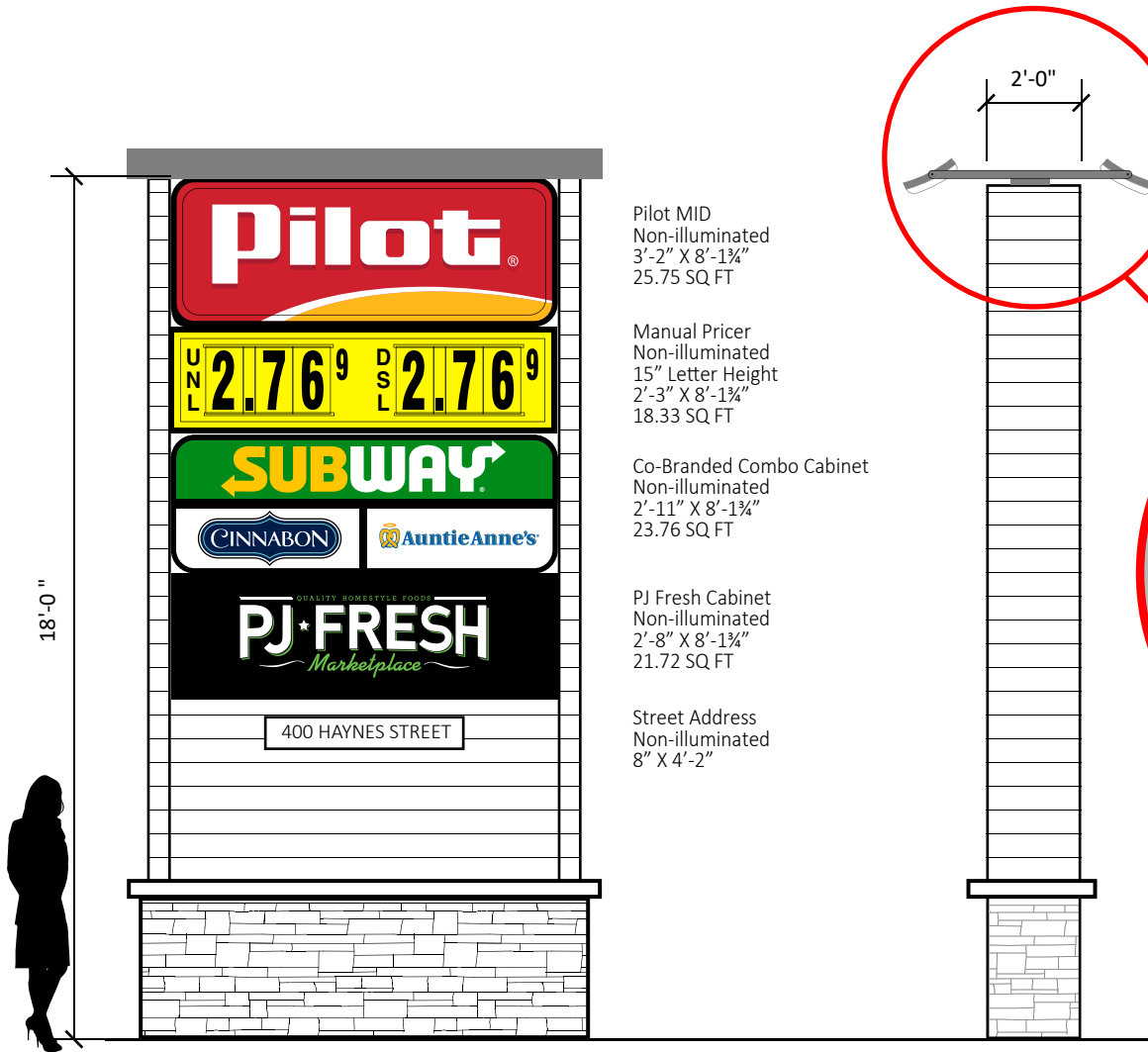

- A1 Fabricate & install NEW Externally Illuminated 18'H Monument system.
- A2 Install External Lighting (Typical Highliner shown).



Font Kit Detail



PROPOSED NORTH ELEVATION

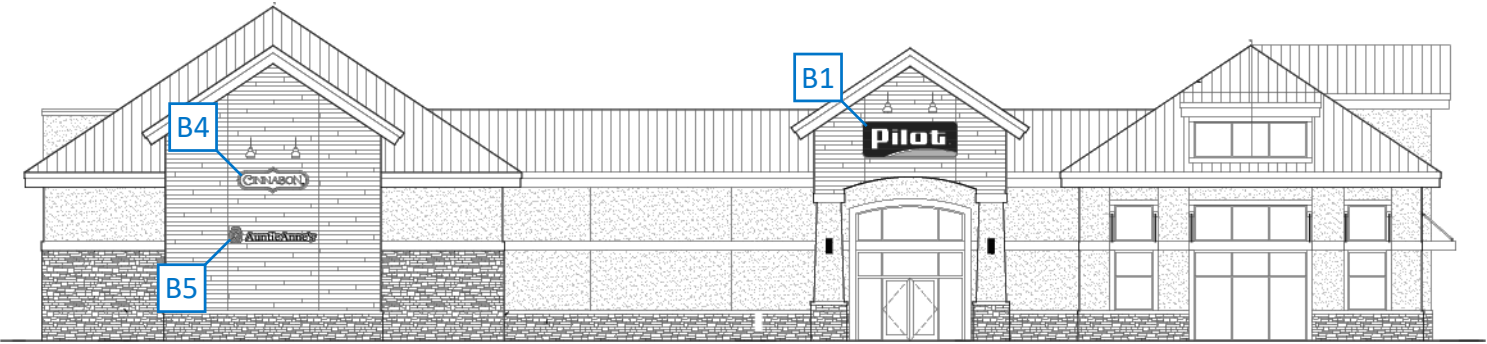

PROPOSED SOUTH ELEVATION



- B1** Replace existing Cabinet with NEW 4'-0"H X 10'-6" SF Pilot Non-illuminated cabinet.
- B2** NEW 10 1/2"H X 12' SF Welcome Drivers Non-Illuminated Channel Letterset
- B4** NEW Cinnabon non-illuminated Wall Sign
- B5** NEW Auntie Anne's Non-illuminated Wall Sign

PROPOSED EAST ELEVATION

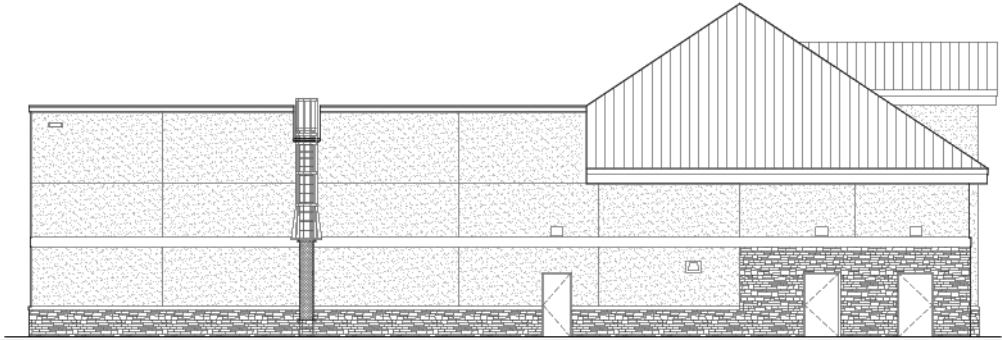

PROPOSED WEST ELEVATION

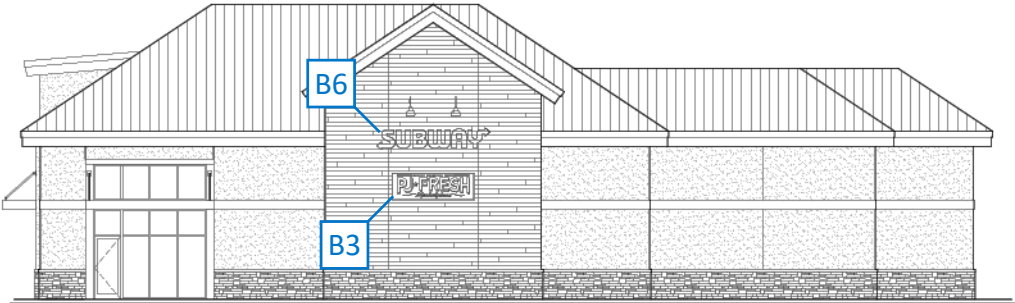

- B3** New Non-illuminated PJ Fresh Vacuum formed Face & Cabinet.
Cabinet to be painted Semi-gloss Black
- B6** NEW Subway non-illuminated Wall Sign

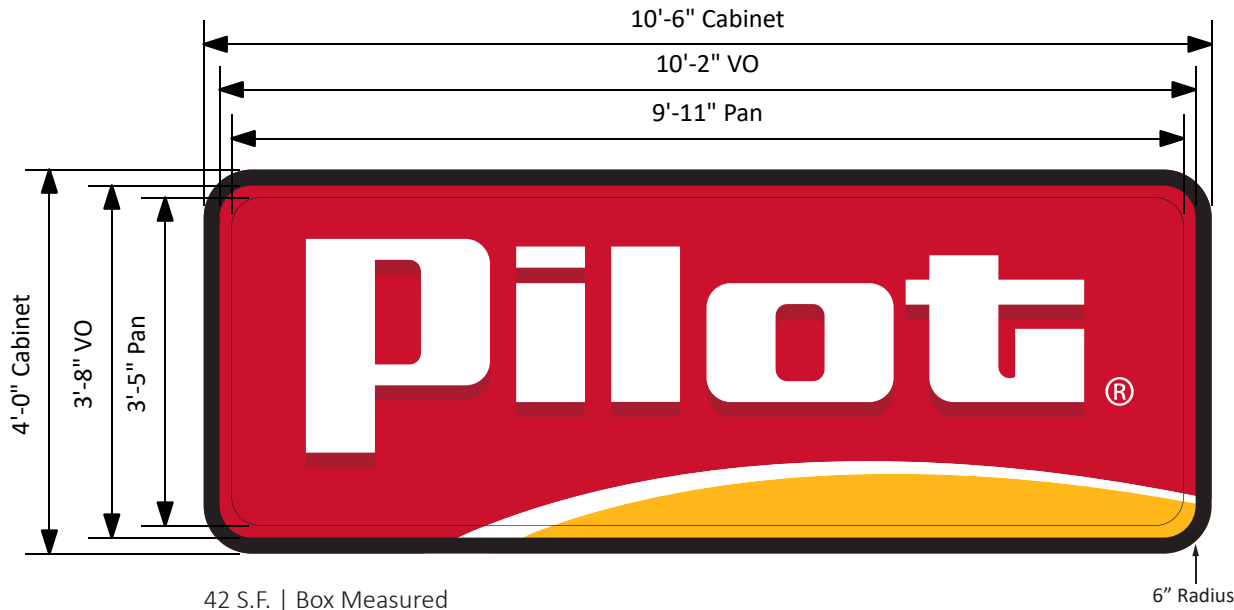

TYPICAL FORMED FACE CROSS SECTION

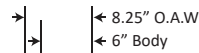
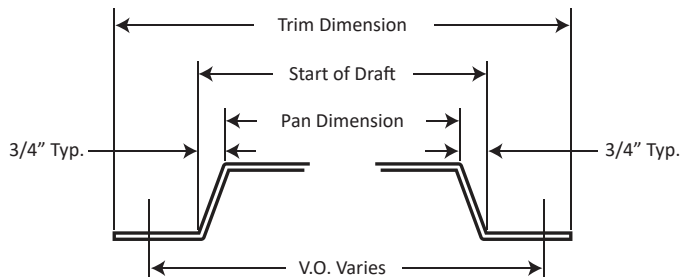

Cabinet Painted Semi-gloss Black
Side View

B1 Replace existing Cabinet with NEW 4'-0" H X 10'-6" SF Pilot Non-illuminated cabinet.

4X10-6 Pan formed Pilot Face & Cabinet

Specifications

Sign Body to be Constructed out of Extruded Aluminum Frame.

Cabinets and Retainers to be Painted Semi-Gloss Black. Faces to be Vacuum Formed out of 3/16" Solar Grade Polycarbonate.

Graphics to be Printed for Back Lit Application (preferred Color/White/Color Process) on 3M IJ3650-114 Clear Vinyl with 3M 8519 Luster Overlaminate. Applied second surface to polycarbonate.

	Pantone 186		Pantone 187
	Pantone 1235		100% White
	Pantone Process Black		

B2 NEW 12"H Welcome Drivers
Non-Illuminated Channel Letterset

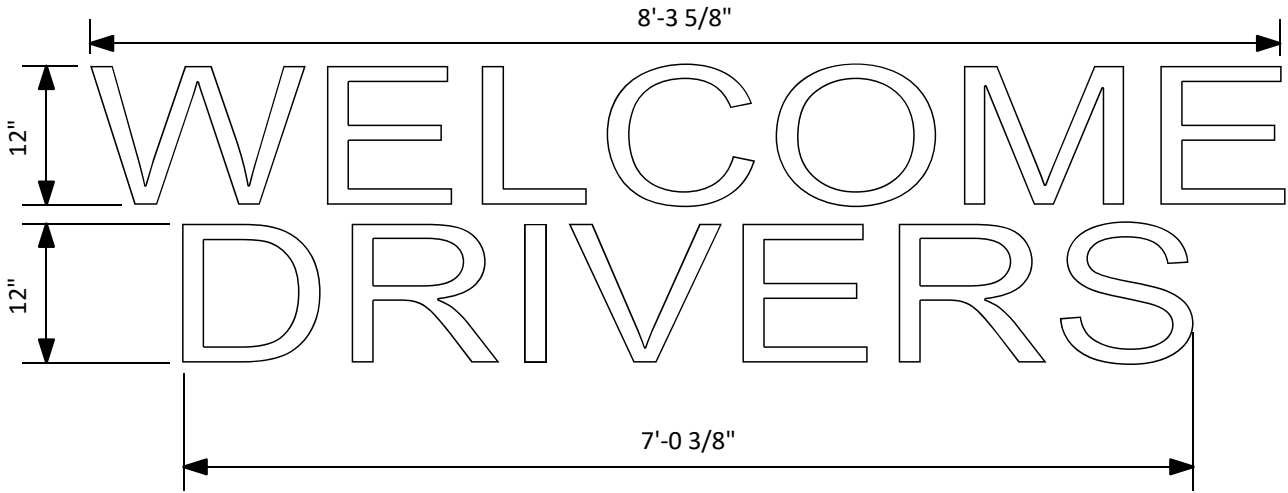
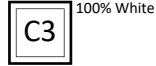

16.00 S.F. | Box Measured





Square Footage: 27.5 S.F.

TYPICAL FORMED FACE CROSS SECTION

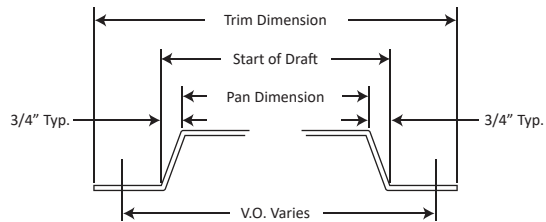

B3 New Non-illuminated Vacuum formed Face & Cabinet.
Cabinet to be painted Semi-gloss Black

Sign Body to be Constructed out of Extruded Aluminum Frame
Cabinets and Retainers to be Painted Semi-Gloss Black
Faces to be Vacuum Formed out of 3/16" Solar Grade Polycarbonate
Graphics to be Printed for Back Lit Application (preferred Color/White/Color Process) on 3M IJ3650-114 Clear Vinyl with 3M 8519 Luster Overlamine

B4 NEW Cinnabon non-illuminated Wall Sign



- C1 Pantone 2768
- C2 Pantone 325
- C3 White Plexi

Square Footage: 23.17 S.F.



B5 NEW Auntie Anne's Non-illuminated Wall Sign

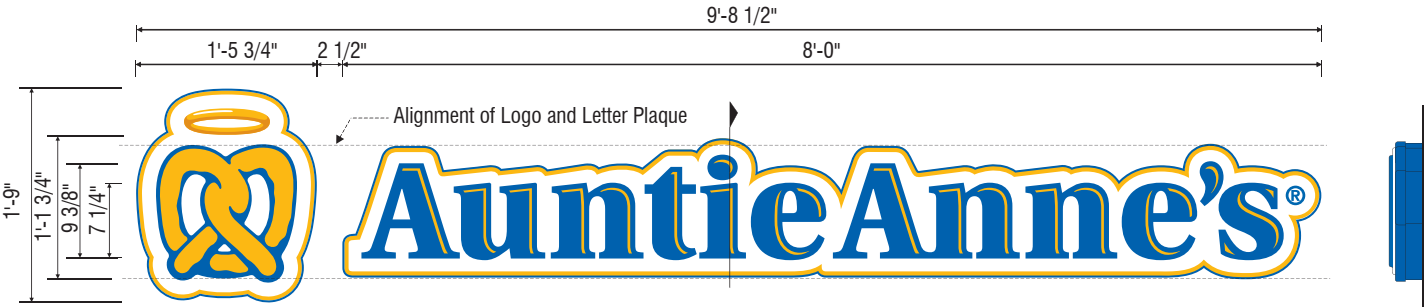

Square Footage: 16.99 S.F.



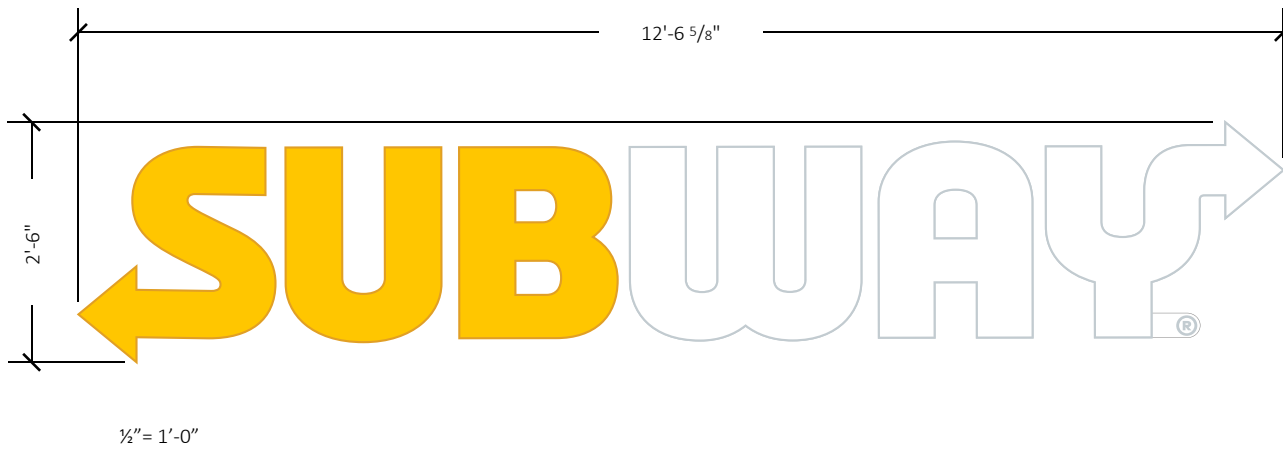

30" LED Non-Illuminated Channel Letter Set Yellow/White

Specifications (SUB):

- 5" Deep Letter
- Aluminum returns factory paint sprayed
Pantone 7548 Yellow
- 7328 White Acrylic Face w/factory paint sprayed Pantone 7548 Yellow Trim Cap
- 3630-75 Yellow vinyl w/3M 3660M Over Laminate

Specifications (WAY):

- 5" Deep Letter
- Aluminum returns factory paint sprayed White
- 7328 White Acrylic Face w/White Trim Cap

Specifications (®):

White vinyl decal on clear polycarbonate placard attached to "Y" letter back

31.38 Sq. Ft. | Boxed Measured

C1	Pantone 7548 C	C2	3M Trans 3630-75 Yellow	C3	100% White
-----------	----------------	-----------	-------------------------	-----------	------------

C1 Canopy to be branded with with Pilot Auto branding.

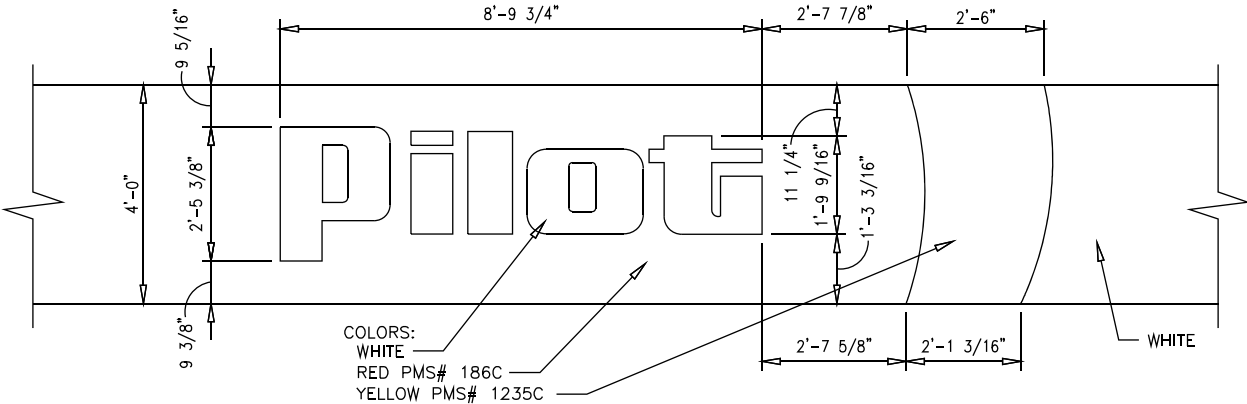

06

SQUARE FOOTAGE: 21.56 SF.



TYPICAL AUTO PRODUCTS CANOPY BRANDING

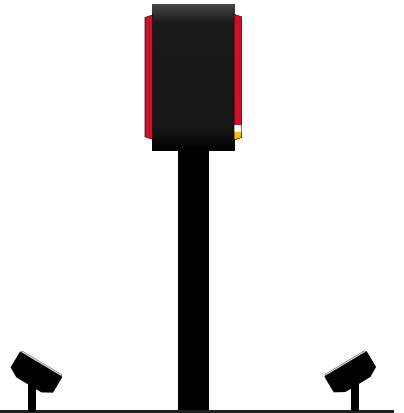
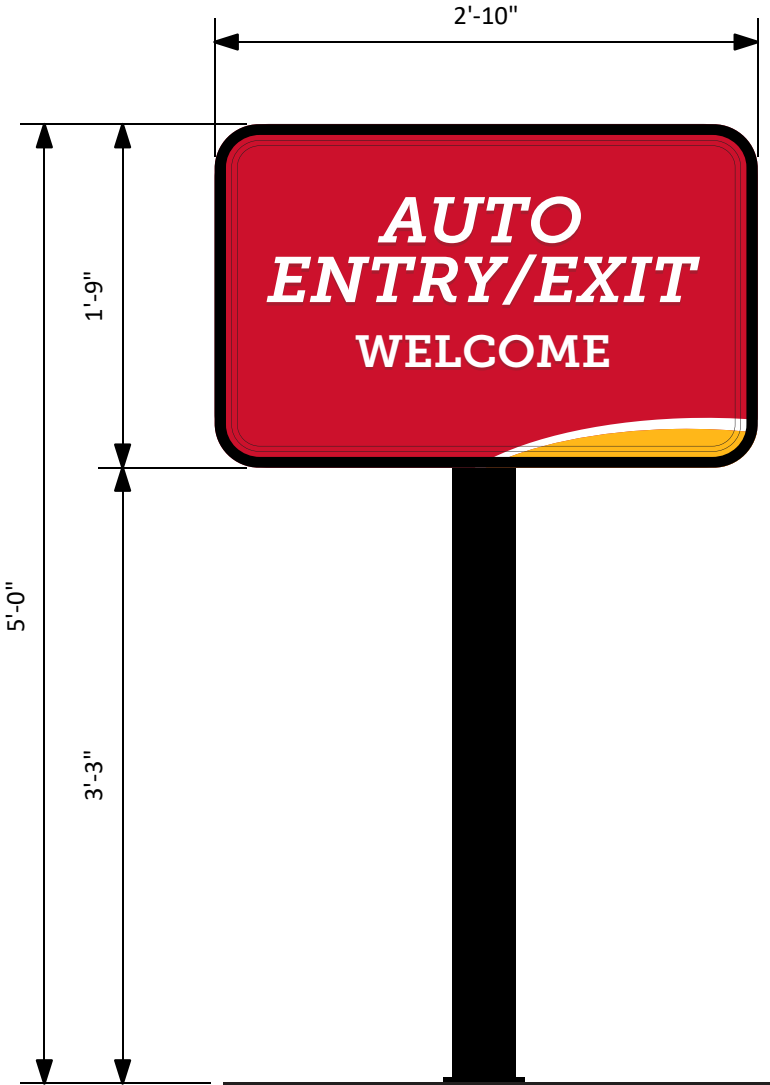

Typical Exterior Lighting Installation

- F1 NEW custom sized Non-Illuminated DF directional.
Fabricate & Install.
Foundation Non-Shrink High Strength grout
Install Exterior flood lighting..

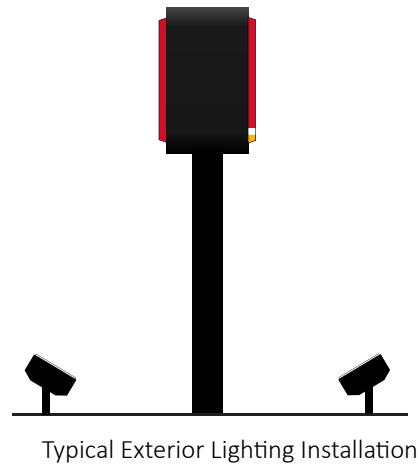
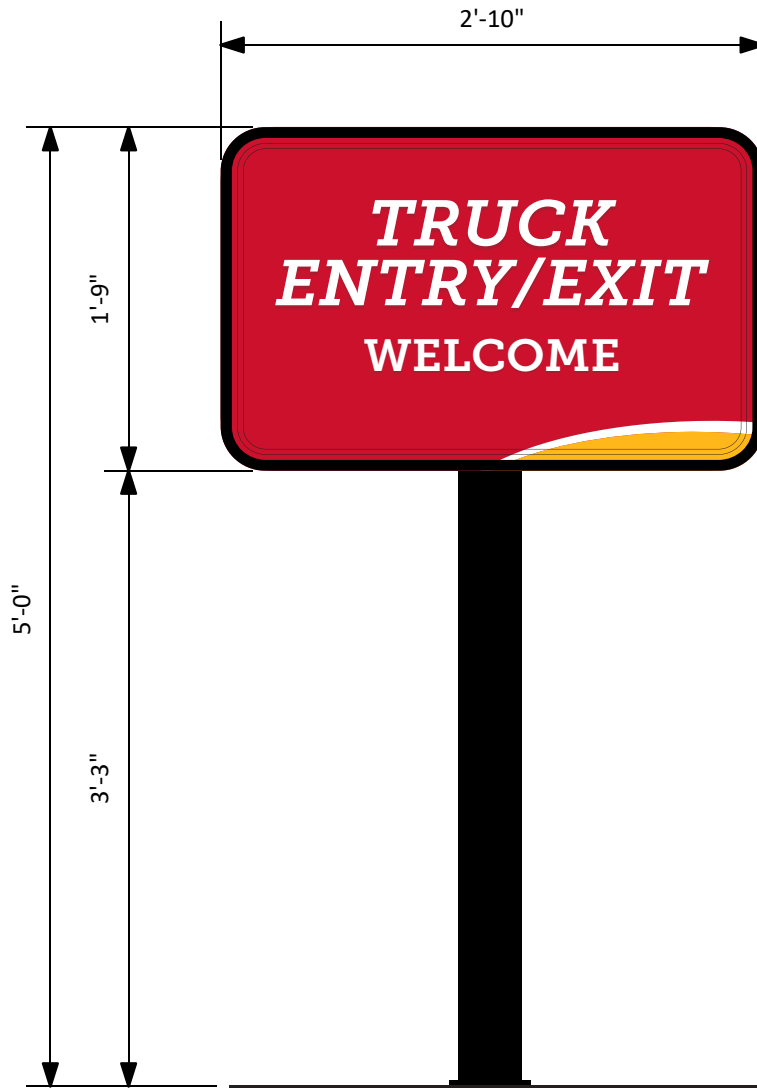

- F2 NEW custom sized Non-Illuminated DF directional.
Fabricate & Install.
Foundation Non-Shrink High Strength grout.
Install Exterior flood lighting.